



Tensioner



Clutch Bearing



Steering Wheel Bearing



Wheel Bearing



Shock Absorber Bearing



One way bearing



【 Wheel Bearing 】

Model	Dimension				Load KN		W. kg	SKF	FAG	KOYO
	d	D	B	C	Cr (N)	Cor (N)				
DAC20420030/2920	20	42	30	29	18.6	14.7	0.17		539816	
DAC25520037	25	52	37	37	25.42	19.73	0.31	445539A	576467	
DAC27520045	27	52	45	45	25.42	19.73	0.36			
DAC28580042	28	58	42	42	33.61	25.68	0.45			DAC28582RS
DAC28610042	28	61	42	42	35.37	28.4	0.47			
DAC27600050	27	60	50	50	35.19	27.82	0.56			
DAC30580042	30	58	42	42	92.74	162.8	0.44			
DAC30600337	30	60.03	37	37	35.37	28.4	0.42	63313C	529891AB 545312	DAC3060W
DAC30620032	30	62	32	32	31.9	25.03	0.41	NACHI30BVV06		



安牧国际

sales@koyoco.com

Jiangsu Amol Bearing Co., Ltd.
Ningbo Amol Intl. Trade Co., Ltd.

DAC30630042	30	63	42	42	35.3	28.6	0.43			
DAC30640042	30	64	42	42	35.3	28.6	0.49			DAC3064WRKB
DAC30680045	30	68	45	45	52.7	39.8	0.52			
DAC307200302	30	72	30.2	30.2	44.4	36.2	0.31			TVB3306
DAC30720037	30	72	37	37	48.9	42.2	0.58	636035		
DAC32720045	32	72	45	45	40.02	34.8	0.60	NSK 32BWD05		
DAC34620037	34	62	37	37	25.42	19.73	0.41	BAHB311316B	531910 561447	IR-8051
DAC34640037	34	64	37	37	37.08	31	0.43	309726DA	5320066DE	DAC3464G1
DAC35640037	35	64	37	37	37.7	32.4	0.45	636114A	580400CA	
DAC35640032	35	64	37	37	37.7	32.4	0.41			DAC3564A-1
DAC35660033	35	66	32	32	37.7	32.4	0.42	445980A		
DAC35660033	35	66	33	33	37.7	32.4	0.43			
DAC35650035	35	66	35	35	38.71	33.34	0.40			
DAC35650035	35	65	35	35	37.7	32.4	0.41			
DAC35660037	35	66	37	37	38.12	32.46	0.48	BAHB311309	544307	
DAC35680233/30	35	68.02	33	30	40.37	34.71	0.47			
DAC35680037	35	68	37	37	40.37	34.71	0.48	BAHB633295	541153A	DAC3568A2RS
DAC35720233/31	35	72.02	33	31	50.91	46.13	0.56			DAC357233B-1W
DAC35720033	35	72	33	33	50.91	46.13	0.58	BA2B445535AE	548038	IR8055
DAC35720443	35	72.04	33	33	48.9	42.2	0.58	633669		IR-8094
DAC35720534	35	72	34	34	48.9	42.2	0.58			DAC3572234A
DAC36680033	36	68	33	33	37.7	32.4	0.50			DAC3668W
DAC36720534	36	72.05	34	34	48.9	42.2	0.58			DAC367234A
DAC37720237	37	72.02	37	37	48.9	42.2	0.59	BA2B633028	527631	GB12807
DAC37720437	37	72.04	37	37	48.9	42.2	0.59	633531	562398A	
DAC38700038	38	70	38	38	44.55	39.64	0.55			DAC3870DW
DAC38710233/30	38	71.02	33	33	44.55	39.64	0.5	38BWD09CA		DAC3871W-2
DAC38700037	38	70	37	37	44.55	39.64	0.52			
DAC38720236/33	38	72.02	36	33	49	41.9	0.54			DAC3872W-3
DAC38720040	38	72	40	40	48.9	42.2	0.63			DAC3872W-10
DAC38740236/33	38	74.02	36	33	52.86	44.38	0.58		574795A	DAC3874W-6
DAC38740050	38	74	50	50	50.7	45.7	0.78	38BWD06	559192	NTNDE0892
DAC39680737	39	68.07	37	37	34.8	32.5	0.48	3113158BD	540733	
DAC39720037	39	72	37	37	48.9	42.2	0.56	BAHB311396B	542186A	DAC3972W4
DAC39/41750037	39/41	75	37	37	47.8	43.13	0.62	BAHB633815A	567447B	
DAC39740039	39	74	39	39	55.56	47.79	0.66	636096A		
DAC40720036/33	40	72	36	33	48.9	42.2	0.54			
DAC40720037	40	72	37	37	48.9	42.2	0.55	BAHB311433	566719	
DAC40740036/34	40	74	36	34	51.26	45.22	0.58			DAC4074CWCS73
DAC40740040	40	74	40	40	50.91	46.13	0.66			DAC407440
DAC40750037	40	75	37	37	50.7	45.7	0.62	BAHB633966		



安牧国际

sales@koyoco.com

















































Jiangsu Amol Bearing Co., Ltd.
Ningbo Amol Intl. Trade Co., Ltd.























































DAC40760033	40	76	33	33	50.91	46.13	0.53	555800		
DAC40760033/28	40	76	33	28	50.91	46.13	0.54	474743	539166AB	
DAC40760041/38	40	76	41	38	52.85	44.37	0.66			DAC4076412RCS
DAC408000302	40	80	30.2	30.2	50.91	46.13	0.70	440320		
DAC40800036/34	40	80	36	34	47.6	42.79	0.73			DAC4080M1
DAC40900046	40	90	46	46	76.28	63.49	0.9			
DAC42720038	42	72	38	38	34.82	31.3	0.55			
DAC427238/35	42	72	38	35	34.82	31.3	0.58			
DAC42750037	42	75	37	37	47.8	43.13	0.59	309245 633196	545495D	DAC4275BW2RS
DAC40760038/35	42	76	38	35	47.8	43.13	0.64			NSK42BWD06
DAC42760039	42	76	39	39	47.8	43.13	0.62			
DAC42760040/37	42	76	40	37	47.8	43.13	0.64	909042	5475059A	DAC427640 2RSF
DAC42800342	42	80.03	42	42	39.6	37.32	0.81	BA2B309609AD	527243C	DAC4280B2RS
DAC42800045	42	80	45	45	39.6	37.32	0.85			DAC4280WHR4
DAC42820036	42	82	36	36	62.3	54.7	0.77	BA2B446047	561481	GB40574
DAC42820037	42	82	37	37	50.7	45.7	0.80	311413	565636	
DAC42840036	42	84	36	36	53.37	44.78	0.88	BA2B444090	564727	
DAC42840039	42	84	39	39	53.37	44.78	0.90	440090	543359B	IR-8101
DAC43790041/38	43	79	41	38	50.7	45.7	0.84			DAC4379-1
DAC43800050/45	43	80	50	45	50.7	45.7	0.95	(NSK) 43BWD03		DAC4380A
DAC43820045	43	82	45	45	50.7	45.7	0.90			DAC4382W-3CS79
DAC45800045	45	80	45	45	50.7	45.7	0.88		564725AB	
DAC45840039	45	84	39	39	62.2	55.1	0.88			
DAC458500302	45	85	32.2	30.2	57.6	52.43	0.83	309797		DAC2004
DAC49840039	49	84	39	39			0.93			
DAC49880046	49	88	46	46	58.7	57.2	0.93	633007C	528514	
DAC50900034	50	90	34	34	58.7	57.2	0.82			















Auto Bearing - Tensioning Wheel

Sc-1001	Sc-1002	Sc-1003	Sc-1004	Sc-1005	Sc-1006
Sc-1007	Sc-1008	Sc-1009	Sc-1010	Sc-1011	Sc-1012
Sc-1013	Sc-1014	Sc-1015	Sc-1016	Sc-1017	Sc-1018
Sc-1019	Sc-1020	Sc-1021	Sc-1022	Sc-1023	Sc-1024
Sc-1025	Sc-1026	Sc-1027	Sc-1028	Sc-1029	Sc-1030
Sc-1031	Sc-1032	Sc-1033	Sc-1034	Sc-1035	Sc-1036
Sc-1037	Sc-1038	Sc-1039	Sc-1040	Sc-1041	Sc-1042
Sc-1043	Sc-1044	Sc-1045	Sc-1046	Sc-1047	Sc-1048

					
Sc-1049	Sc-1050	Sc-1051	Sc-1052	Sc-1053	Sc-1054
					
Sc-1055	Sc-1056	Sc-1057	Sc-1058	Sc-1059	Sc-1060
					
Sc-1061	Sc-1062	Sc-1063	Sc-1064	Sc-1065	Sc-1066
					
Sc-1067	Sc-1068	Sc-1069	Sc-1070	Sc-1071	Sc-1072
					
Sc-1073	Sc-1074	Sc-1075	Sc-1076	Sc-1077	Sc-1078
					
Sc-1079	Sc-1080	Sc-1081	Sc-1082	Sc-1083	Sc-1084
					
Sc-1085	Sc-1086	Sc-1087	Sc-1088	Sc-1089	Sc-1090
					
Sc-1091	Sc-1092	Sc-1093	Sc-1094	Sc-1095	Sc-1096

					
SC-5019	SC-5020	SC-5021	SC-5022	SC-5023	SC-5024
					
SC-5025	SC-5026	SC-5027	SC-5028	SC-5029	SC-5030
					
SC-5031	SC-5032	SC-5033	SC-5034	SC-5035	SC-5036
					
SC-5037	SC-5038	SC-5039	SC-5040	SC-5041	SC-5042
					
SC-5043	SC-5044	SC-5045	SC-5046	SC-5047	SC-5048
					
SC-5049	SC-5050	SC-5051	SC-5052	SC-5053	SC-5054
					
SC-5055	SC-5056	SC-5057	SC-5058	SC-5059	SC-5060
					
SC-5061	SC-5062	SC-5063	SC-5064	SC-5065	SC-5066
					
SC-5067	SC-5068	SC-5069	SC-5070	SC-5071	SC-5072

					
Sc-1097	Sc-1098	Sc-1099	Sc-1100	Sc-1101	Sc-1102
					
Sc-1103	Sc-1104	Sc-1105	Sc-1106	Sc-1107	Sc-1108
					
Sc-1109	Sc-1110	Sc-1111	Sc-1112	Sc-1113	Sc-1114
					
Sc-1115	Sc-1116	Sc-1117	Sc-1118	Sc-1119	SC-1120



【 Clutch Release Bearing 】

					
SC-5001	SC-5002	SC-5003	SC-5004	SC-5005	SC-5006
					
SC-5007	SC-5008	SC-5009	SC-5010	SC-5011	SC-5012
					
SC-5013	SC-5014	SC-5015	SC-5016	SC-5017	SC-5018

SC-5067	SC-5068	SC-5069	SC-5070	SC-5071	SC-5072
SC-5073	SC-5074	SC-5075	SC-5076	SC-5077	SC-5078
SC-5079	SC-5080	SC-5081	SC-5082	SC-5083	SC-5084

Shock Absorber Bearing

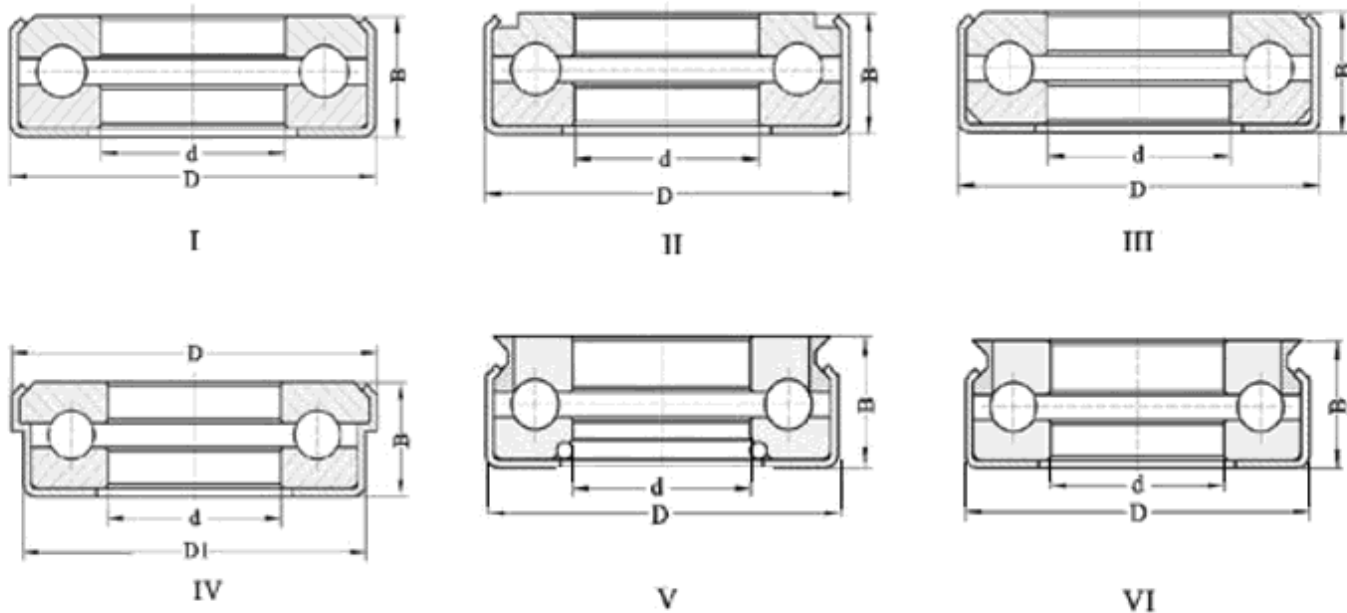

轴承型号	对照型号	尺寸 (mm)			结构
		d	D	B	
12TAG285142	TS12-151	12.8	28.575	14.2825	I
15TAG290095	51102K	15	29	9.5	I
18TAG390143	T-19	18.6	39	14.3	I
19TAG415135	20020B	19.6	41.5	13.5	I
20TAG340105	51104N	20	34	10.5	I
20TAG380105	F-20	20	38	10.5	I
20TAG390143	T-20	20	39	14.3	I
20TAG372107-RS	TAG20-4A	20	37.2	10.7	VI
21TAG415143	TAG21-1	21	41.5	14.3	II
22TAG363080	7037	22.6	36.3	8.0	I
22TAG400128	Y-22-1	22	40	12.8	I

22TAG436148	T-22	22	43.6	14.8	I
23TAG425158	T-23	23.4	42.5	15.8	I
23TAG482150	T-94B	23.544	48.201	15.088	I
25TAG435118	25TAG11	25	43.5	11.8	I
25TAG435118-RS	25TAG11C	25	43.5	11.8	VI
25TAG450138	Y-25-3	25	45	13.8	I
25TAG450140-2RS	Y-25-5B	25	45	14	V
25TAG450158-2RS	25TAG001	25	45	15.8	V
25TAG460160	T-25-1	25	46	16	I
25TAG487158-RS	25TAG12C	25	48.7	15.8	VI
25TAG487160	25TAG12	25	48.7	16	I
25TAG545090	25TAG003	25	54.5	9.0	I
28TAG470160	T-2847	28	47	16	I
28TAG516158	28TAG12	28	51.6	15.8	I
28TAG516158-2RS	28TAG12A\28TAG12E	28	51.6	15.8	V



I

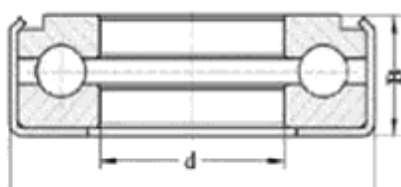

II



III

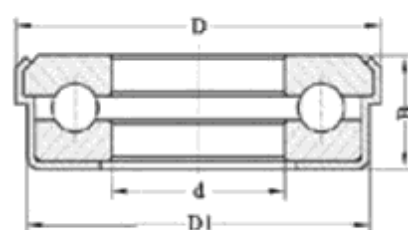

IV



V

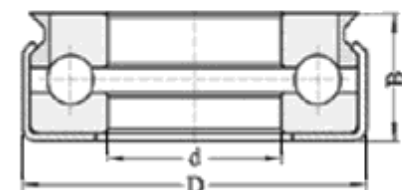

VI

轴承型号	对照型号	尺寸 (mm)			结构
		d	D	B	
28TAG516160-RS	28TAG12A-1	28.2	51.6	16	I
28TAG530164	T-28S-1	28.15	53	16.4	II
28TAG530165	T-28/T-28-1	28	53	16.5	I
28TAG530165-2RS	028TG05-2	28	53	16.5	V
28TAG531158	T-110B	28.729	53.181	15.875	I
28TAG545090	Y-28-2DB	28	54.5	9.0	I
28TAG545140	F-280	28	54.5	14	IV
28TAG545093	T-28RO-1	28	54.5	9.3	IV
28TAG555157	3073	28.207	55.562	15.748	I

28TAG555158	T-1113B(81T-3123B)	28.729	55.562	15.875	I
30TAG516138-2RS	Y-30-1AB	30	51.6	13.8	V
30TAG516170-RS	30TAG001	30	51.6	17	VI
30TAG528138-2RS	Y30-1AB	30.15	52.8	13.8	V
30TAG530170	30TAG12	30	53	17	I
30TAG558159	Y-30Z-1B	30.5	55.8	15.9	III
31TAG555158	T-126B(7EQ-O)	31.094	55.562	15.875	I
32TAG570170	32TAG12PXI	32.1	57	17	I
35TAG627167-2RS	T3563RS-2	35.2	62.7	16.7	V
35TAG627168	T3563RS2	35	62.7	16.8	II
35TAG627176-2RS	T-3563RS5	35	62.7	17.6	V
35TAG627170	T-3558	35	62.7	17	I
35TAG640190	35TAG12	35	64	19	I
35TAG650162	TK-35	35.4	65	16.2	I
35TAG650180	CRT0752B	35	65	18	II
35TAG650183	F-35A	35	65	18.3	I
35TAG650183-2RS	35TAG802B	35	65	18.3	V



I

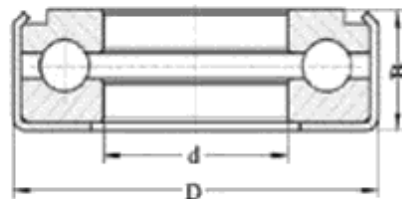

II

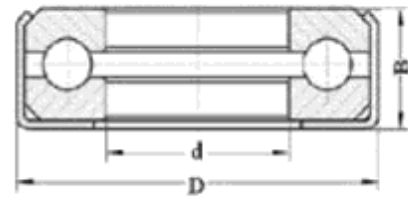

III

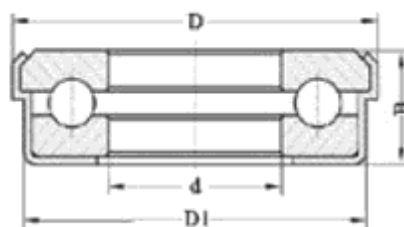

IV

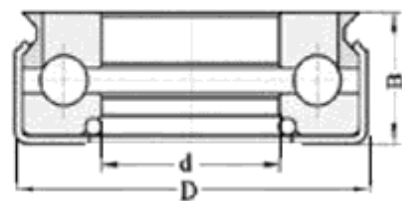

V

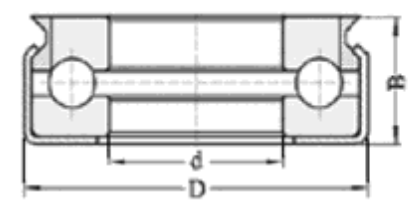

VI



安牧国际

sales@koyoco.com

Jiangsu Amol Bearing Co., Ltd.
Ningbo Amol Intl. Trade Co., Ltd.

F1-100-999	42.4	21.5	14	钢球 steel ball
F83345	43	23.5	9.5	滚针
MK29-999	42.5	8	17	钢球
72A	43.5	24.1	10.8	二个罩壳
72VB-3123	43.5	27.3	12	二个罩壳
Y25-3	46.1	25.5	15.8	钢球
T-25-1	46.1	25.5	13	钢球
F887836	43	26	12	滚针
47×25×9.5	47	25.2	9.5	滚针
25TAG12C	48.7	25.2	15.8	钢球
520-115	48.2	27	12.1	摩擦片
BE-89	48.2	27	12.1	摩擦片
520-132	48	24	15.2	钢球
Y30-1AB	51.6	30.2	14.5	钢球
28TAG12	51.3	28.2	16	钢球
30TAG001	51.3	30.2	17	钢球
T28S1	53.2	28.2	16.5	钢球
Y30-2F	54.1	30.4	14	钢球
B-101	55	32.4	14	滚子
B-106	55	30.1	16	滚子
B-130	55	34.2	16	滚子
9S4-888	55	30.6	16	滚子
T119	55	30.3	16	滚子
T113	55	28.8	16	滚子
T126	55	32	16	滚子
BE-1	55.7	29	16	钢球
T126 满珠	55	31.5	16	滚子
RT139	58.5	35.1	16.2	滚子
T139	58.5	35.1	16.2	滚子
CRT0752A	65	35.3	18	钢球
F35	65	30.1	18.3	钢球
T144	66.3	37.3	19.8	滚子
T149	66.3	38.4	19.5	滚子
TAG40-1	70	40.2	19.3	钢球
TAG45-1	72	45.1	14.8	钢球
T4253	72.5	40.1	19.3	滚子
WLKP074	72.5	39	20.8	滚子
407219	72.5	41.5	19.6	滚子
BE-280	72.5	40.2	21.6	滚子
T177	73.6	48	19.8	滚子
T1760	76	44.7	11	滚针
T4255	78	46.2	21.6	滚子
TAG47-1	78	47.6	22.9	钢球

轴承型号	对照型号	尺寸(mm)			结构
		d	D	B	
35TAG650190	TO722PX1	35	65	19	I
35TAG658107	TK-66/TK-35S	35.4	65.88	10.7	I
38TAG658186	F-38Z-5	38.103	65.88	18.6	I
38TAG658194	Y-38	38.103	65.88	19.431	I
38TAG720220	T-151	38.4	72	22	I
40TAG700188	T-40S-3	40.2	70	18.8	II
40TAG700200	40TAG12-1A	40	70	20	I
40TAG700200-2RS	40TAG12B1	40	70	20	V
40TAG725190-2RS	T4072-RS	40	72.5	19	V★
40TAG725210-2RS	T4072RS	40	72.5	21	V
40TAG756200	T-40-3	40.2	75.6	20	I
45TAG720150	TAG-45-1	45	72	15	I
45TAG725220	Y-45	45	72.5	22	I
45TAG725220A	CRT3953B	45	72.5	22	II
45TAG745230	T-909	45	74.5	23	I
47TAG780230	TAG47-1	47	78	23	I
47TAG780230-2RS	47TAG001	47	78	23	V
50TAG756190	F-50-4	50	75.6	19	I
50TAG756200	TH15-6631	50	75.6	20	I
50TAG800188-2RS	50TAG001/Y-50-9B	50	80	18.8	V
50TAG820190-2RS	T5082-RS	50	82	19	V★
50TAG820210-RS	T5082RS	50	82	21	VI
50TAG820220	TK50RC	50	82	22	II
50TAG820240-2RS	T508RSGA2	50	82	24	V
55TAG910260-2RS	55TAG001K	55	91	26	V

Shock Absorber Bearing

轴承型号	外径 D mm	内径 d mm	高度 B mm	结构型式
TAG20-4A	36.6	20.1	11	钢球
73A	40	23	9.3	二个罩壳
Y22-1	40	22.2	12.4	钢球
BE-14	41.5	22.2	14.4	钢球
520-117	41.5	22.2	13.6	摩擦片
BE-44	41.5	22.2	13.2	钢球
H-10	42.4	21.5	14	钢球

528548B	78	50.3	22	滚子
353263E	80	44.9	16.4	滚子
Y50-9B	80.1	50.2	18.8	钢球
TK50RC	80	50.1	21.8	滚子
T5082RS	82.3	50.3	19.6	钢球
T163	82.7	41.6	21.3	滚子带底盘
T182	83	50	24	滚子
468324	83	46.3	24.1	滚子
T1822S	83	46.3	17.3	滚子
T182S	85.5	46.5	25	滚子
T188S	85.5	47.8	24	滚子
T194S	93.5	49.5	28.3	滚子
T208S	98	49.5	28.2	滚子
T208	98	52.6	28.2	滚子
130-303	80	50.1	22	滚子 塑保器
T200A	110	51	22.25	滚子

Steering Wheel Bearing

轴承型号	外径 D mm	高度 B mm	内径 d mm	结构型式
128202K	35	10.5		外套
15BSW02	35	10		外套
ACS0304-2	35	10.5		外套
VBT15Z-2	35	11		外套
VBT17Z-2	38	10.9		外套
128802	38.1	11.1		外套
ACS0304	40	11		外套
ACS0404	41	12		外套
ACS040412	43	12.5		外套
VBT17Z-3	40	11		外套
VBT17Z-4	40	10.9		外套
VBT21Z-1	42	13.5		外套
VBT20Z-1	44	12		外套
17VBSW02	42	13		外套

VTAA19Z-1	41	11.5		外套 Outer Ring
VTAA19Z-4	41	12		外套
ACS040514	47	14.3		外套
ACS0405D-2	52	15		外套
128702	44	12		外套
128602	48	13.5		外套
3401R-100	52	15		外套
S9072	60	6		外套
15BCW02	35	11	15	内外套 OR_IR
15BSW06B	35.2	12	15	内外套
9168304	47	16	20	内外套
20BSW01	52	15	20	内外套
20BSW04A	52	17	20	内外套
ACS0405J-4	47	11	19.50	内外套
ACS0405J-2	47	13.5	19.50	内外套
BT18Z-1B1	38	10	18.72	内外套
BT19Z-1A	47	16	22	内外套

【 One way Bearing 】

轴承型号 Model	外径 D mm OD	高度 B mm Height	内径 d mm ID	公称转矩 Tn(N.m) Torque	轴承系列 Bearing Sr.	质量 kg Weight
CSK8	22	9	8	2.5	608	0.015
CSK12	32	10	12	7.4	6201	0.04
CSK15	35	11	15	13.5	6202	0.06
CSK17	40	12	17	24.5	6203	0.07
CSK20	47	14	20	40	6204	0.11
CSK25	52	15	25	88	6205	0.14
CSK30	62	16	30	110	6206	0.21



安牧国际

sales@koyoco.com

Jiangsu Amol Bearing Co., Ltd.
Ningbo Amol Intl. Trade Co., Ltd.

CSK35	72	17	35	140	6207	0.30
CSK40	80	22	40	260	6208	0.50

CSK 系列当于 FAG 公司的 ZZ 系列；STIEBER 公司 KK 系列；GMN 公司的 FK62 系列产；DANA 公司的 BB 系列；国内 OW 系列。如用户需要,内、外环可制作键槽